

# Printed Circuit Boards (PCBs)

## Trough Up-Kicker Dual OPTO PCBs (515-0173-00 & 515-0174-00) Theory of Op. & Schematic

As light from the **Transmitter LED1** falls on the **Receiver LED1**, it generates a Positive Bias Voltage (0.7v to 1.5v) which is applied to the **Gate (G)** of **Q1 (Fet 2N5460)** turning **Q1** off. When **Q1** is held off, no current flows through **Q2's (2N3906) Base (B)**. With no *base current*, **Q2** is off and acts as an **OPEN SWITCH**. When the light is interrupted (**BLOCKED**) **R1** (Rec. Bd.) bleeds the gate voltage off of **Q1** allowing it to conduct, switching **Q2** on, which acts as a **CLOSED SWITCH**. The **LED2 (Trans/Rec) Circuit** operates identical as the **LED1 Circuit**.

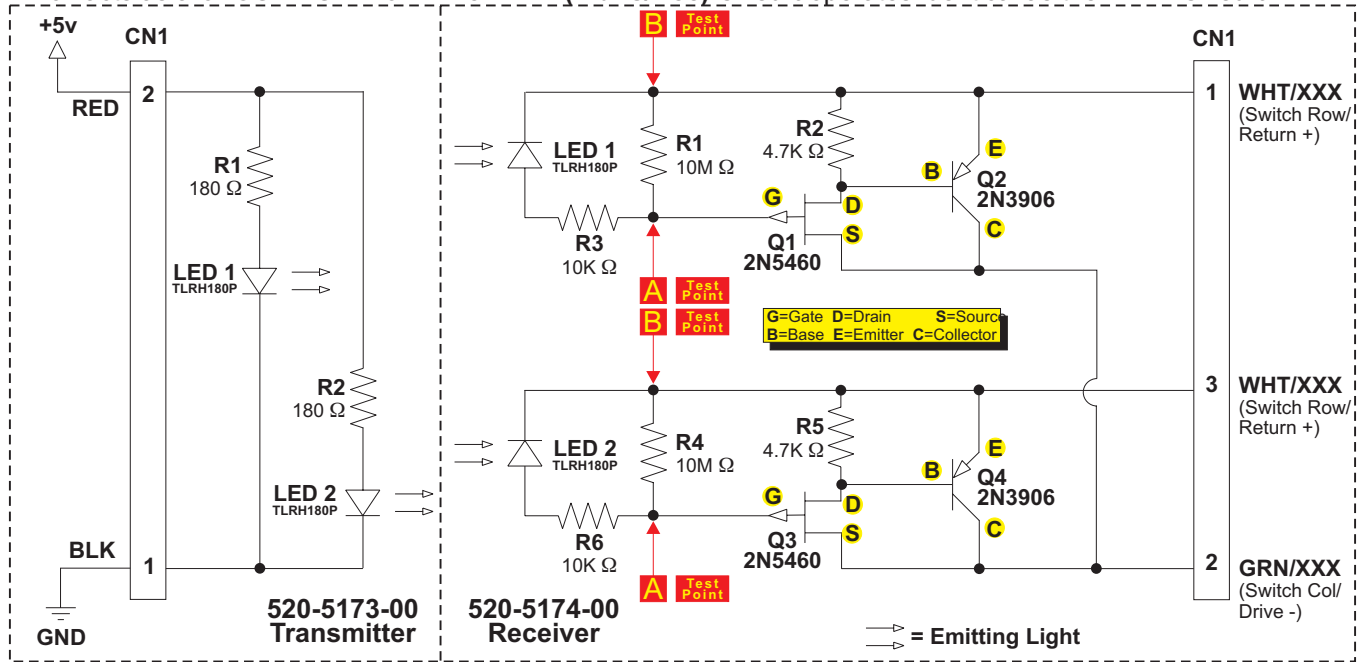

## Trough Up-Kicker Dual OPTO PCBs (515-0173-00 & 515-0174-00) Component Layout & Parts

520-5173-00 (TRANS)

Boards Actual Size  
(Screened Text Printed Larger for Clarity)

520-5174-00 (REC)

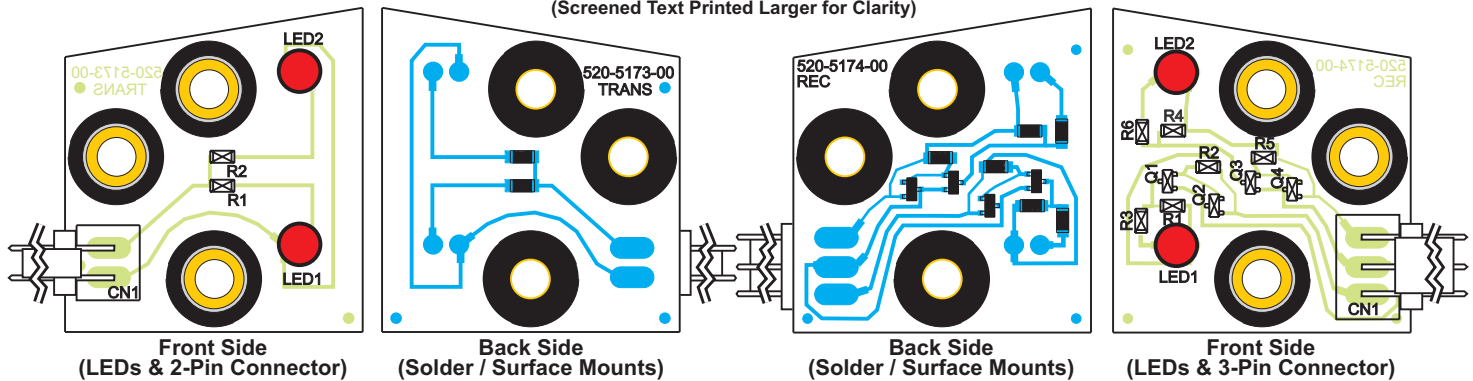

ITEM	QTY	PART NUMBER	REF-DESIGNATOR	DESCRIPTION
A+C & D	1	515-0173-00		Dual-OPTO Transmitter PCB Assembly (Item A PCB + Items C & D)
A	1	520-5173-00		Dual-OPTO Transmitter PCB
A-1	1	045-5111-02	CN1	(includes Items A-1 – A-3) 2X, .156" Rt. Angle (26-60-5020) Conn.
A-2	2	165-5052-00	LED1, LED2	LED TLRH180P (Ultra Bright Red)
A-3	2	121-5067-00	R1, R2	180 Ω Resistor SMT, 1/8W (CRCW)
B+C & D	1	515-0174-00		Dual-OPTO Receiver PCB Assembly (Item B PCB + Items C & D)
B	1	520-5174-00		Dual-OPTO Receiver PCB
B-1	1	045-5111-03	CN1	(includes Items B-1 – B-7) 3X, .156" Right Angle (26-60-5030) Conn.
B-2	2	165-5052-00	LED1, LED2	LED TLRH180P (Ultra Bright Red)
B-3	2	110-5006-00	Q1, Q3	2N5460, Transistor (P-FET SOT-23)
B-4	2	110-0086-00	Q2, Q4	2N3906, Transistor
B-5	2	121-5082-00	R1, R4	10M Ω Resistor SMT, 1/8W (CRCW)
B-6	2	121-5083-00	R2, R5	4.7K Ω Resistor SMT, 1/8W (CRCW)
B-7	2	121-5011-00	R3, R6	10K Ω Resistor SMT, 1/8W (CRCW)
C	3/per	530-5308-02		OPTO PCB Brass Tube Spacer
D	3/per	545-5518-00		OPTO PCB Rubber Grommet

Replacement Part:  
LED TLRH180P  
(T1-3/4 GaAIAs)  
SPI Part N<sup>o</sup>:  
165-5052-00



# OPTO Troubleshooting

## 1. Volt Meter Test (indicates normal operating condition):

A. **OPEN OPTO** (Light Falling on LED) = *SWITCH OPEN*. Place meter leads across points **A** and **B** on the **LED1 Circuit** (Refer to Schematic Drawing on previous page, 520-5174-00 Receiver Side). It should read approximately 0.8 - 1.2v DC. The **LED2 Circuit** operates the same.

B. **CLOSED OPTO** (Light Blocked) = *SWITCH CLOSED*. Place meter leads across points **A** and **B** on the **LED1 Circuit** (Refer to Schematic Drawing on previous page, 520-5174-00 Receiver Side). It should read approximately 0.0 - 0.1v DC. The **LED2 Circuit** operates the same.

## 2. Oscilloscope Test (indicates normal operating condition):

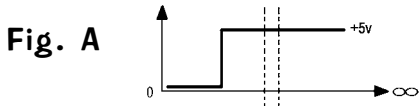

A. **OPEN OPTO** (Light Falling on LED) = *SWITCH OPEN*. Place Scope lead at **Pin-1** of OPTO Rec. Board with Scope Grounded (see Schematic). The Scope should display a **STEADY +5v** as shown in **Fig. A**, Wave Form Diagram.

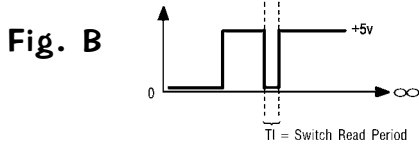

B. **CLOSED OPTO** (Light Blocked) = *SWITCH CLOSED*. Place Scope lead at **Pin-1** of OPTO Rec. Board with Scope Grounded (see Schematic). The Scope should display a **PULSE STREAM** indicating **Q2** has switched "On" as shown in **Fig. B**, Wave Form Diagram. This is your Switch Drive Pulse.

## 3. Bench Test (See Fig. C):

Please Note: To perform this test you must use a spare 560Ω Pull-Up Resistor, SPI N<sup>o</sup>: 121-5047-00

Disconnect the **OPTO Transmitter / Receiver Board** from the circuit. Connect one side of a 560Ω Pull-Up Resistor to **Pin-1** of the OPTO Receiver Bd. and the other side of the resistor to a 5v DC source. Connect **Pin-2** to GND. Connect a +5v DC source to **Pin-1** of the Transmitter & GND to **Pin-2**. Align with the Receiver OPTO approx. 3" distance. Using your Volt-Meter or an Oscilloscope, monitor **Pin-1** while **BLOCKING** and **UNBLOCKING** the **BEAM** from the Trans. The output will be approx. +5v DC when the **BEAM IS NOT BLOCKED** and approx. 0v when the **BEAM IS BLOCKED**.

Fig. C

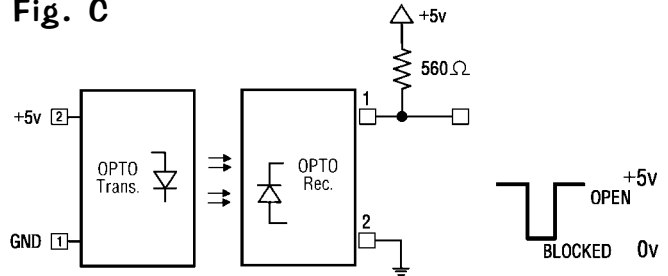

## Trough Dual OPTO Boards Alignment / Test for LED1

When a working **OPTO** is installed and connected in a game, the transmitter should light (**LED1 lower & LED2 upper**) when the power is switched on. With the playfield in **Service Position #1** (playfield lifted up in the half-way position resting on the Prop Rod or edge slide support brackets) and the game on, the LED lights should show up as a **BRIGHT RED RINGS** through the back of the Receiver Board around the **Receivers LED1 & LED2** (see **Fig. 1**). Testing only **LED1**: With the game in **Switch Test Mode**, lifting the Trough Plunger with a fingertip should block the **BEAM** and cause the Switch Position to trigger (see **Fig. 2**). View **Fig. 2a & 2b** (on the next page) for a sectional view of the Light Path (note alignment) and what happens as a ball breaks the light beam.

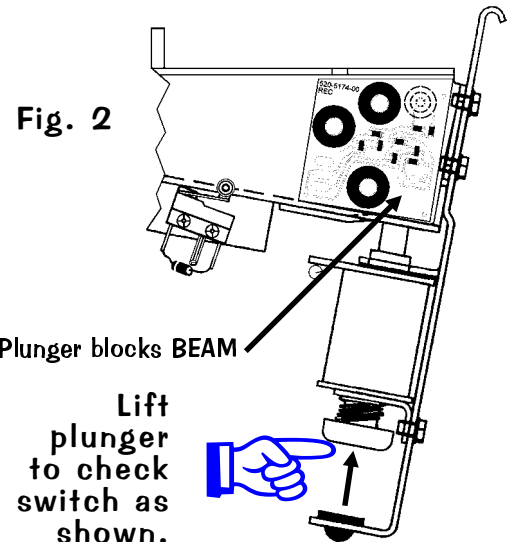
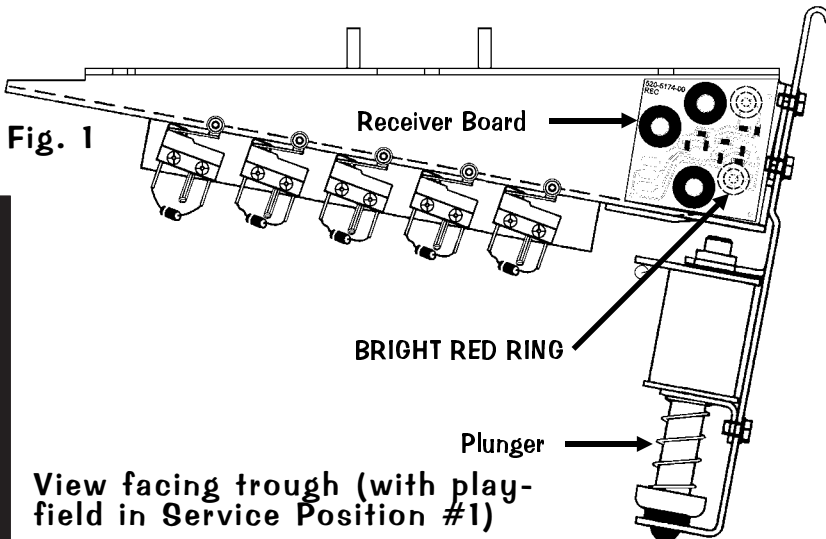

Sec. 5: PCBs



## Sectional view from right (Fig. 2a & 2b)

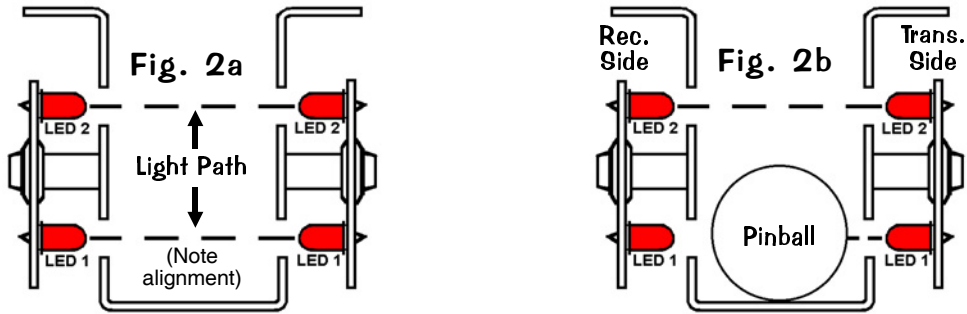

### Trough Dual OPTO Boards Alignment / Test for LED2

When a working **OPTO** is installed and connected in a game, the transmitter should light (**LED1 lower & LED2 upper**) when the power is switched on. With the playfield in **Service Position #1** (playfield lifted up and resting on the Playfield Support Slide Brackets) and the game on, the LED lights should show up as a **BRIGHT RED RINGS** through the back of the Receiver Board around the **Receivers LED1 & LED2** (see Fig. 1, previous page). Testing only **LED2**: **TO PERFORM THIS TEST, A PINBALL MUST BE IN THE BALL TROUGH.** With the game in **Switch Test Mode**, lifting the Trough Plunger with a finger tip should block the **BEAM** on LED2 and cause the Switch Position to trigger (see Fig. 3). View Fig. 3a & 3b for a sectional view of the Light Path (note alignment) and what happens as a "double-stacked" ball scenario breaks the light beam.

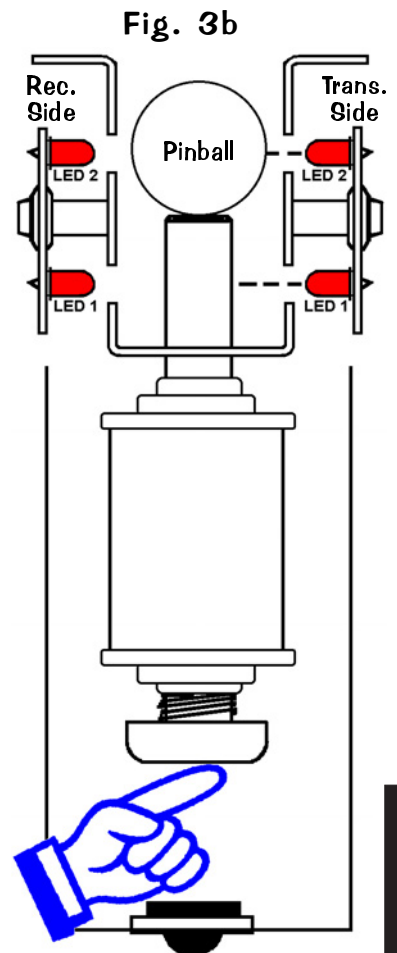
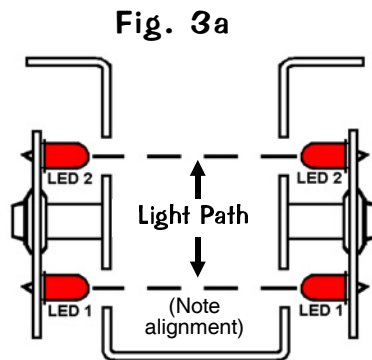
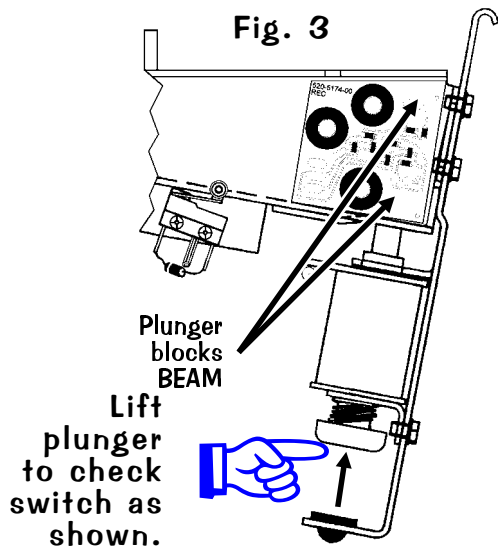

## I M P O R T A N T

If replacement of **LED** is required, insure that is **mounted correctly before and after soldering** (See Fig. 4a / 4b).

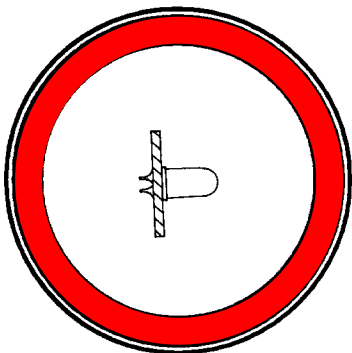

Fig. 4a  
Correct Position

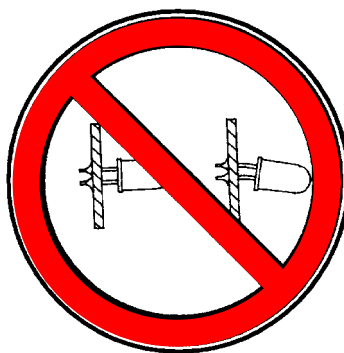

Fig. 4b  
Incorrect Position